

# 1. Matériel

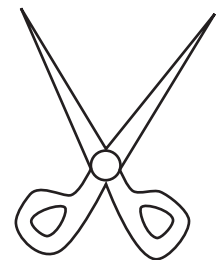
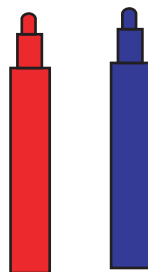
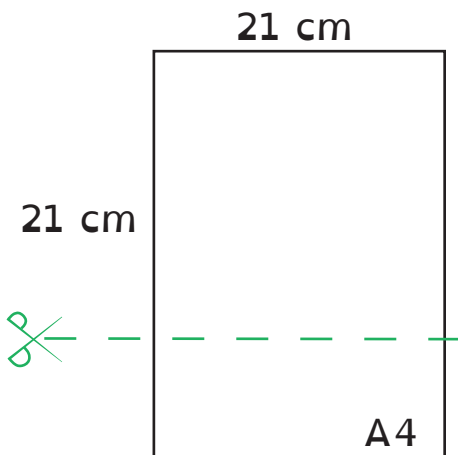
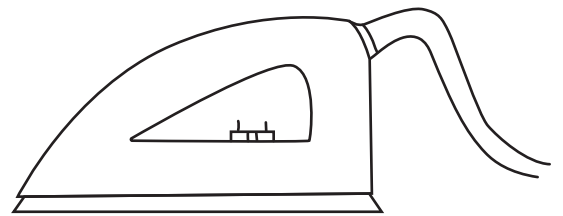
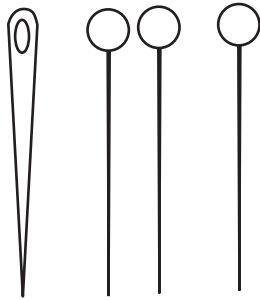
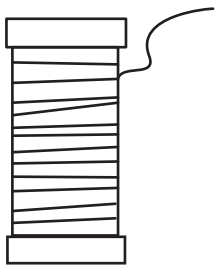
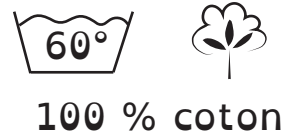
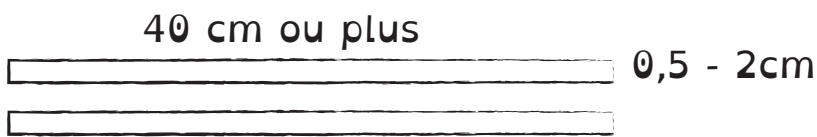
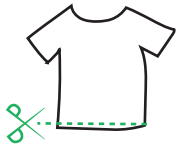
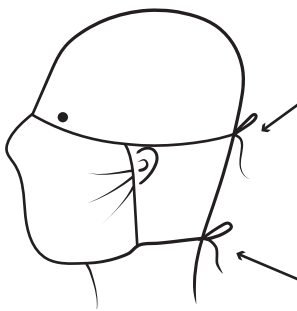
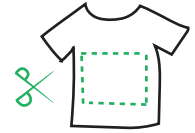
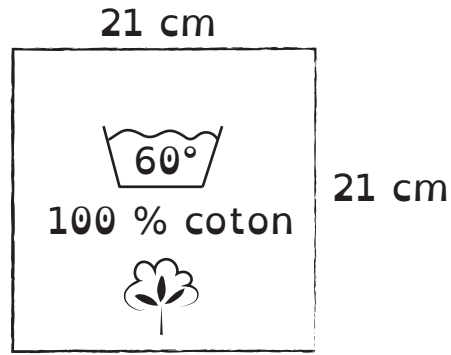
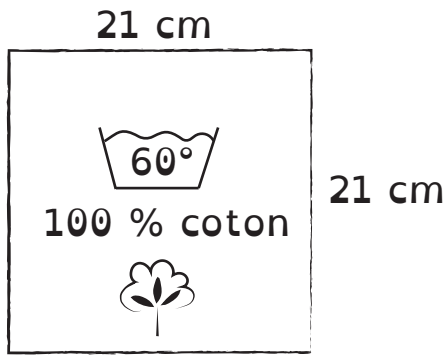

# 2. Patron

7cm

1cm

2cm

1cm

2cm

1cm

7cm

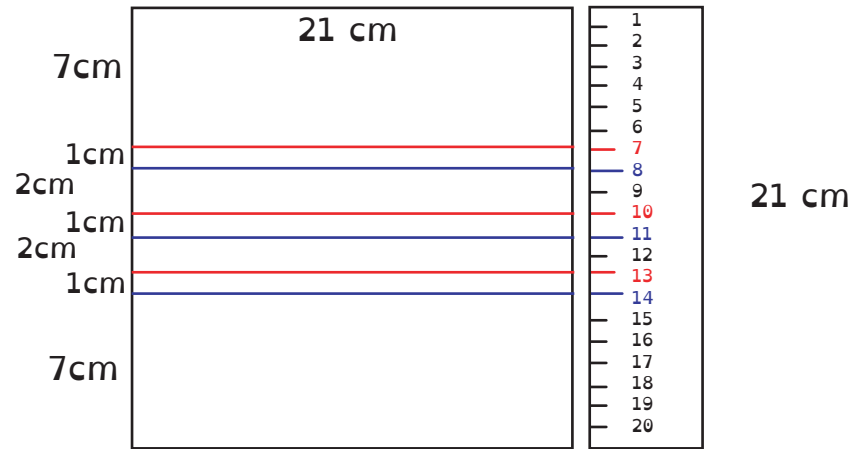

### 3. Plier

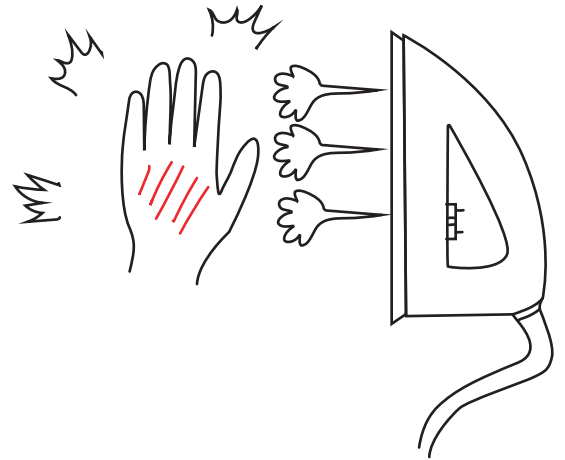
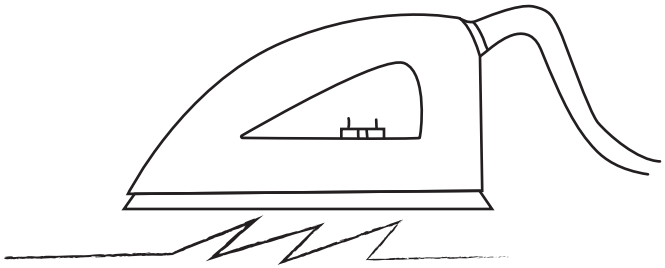
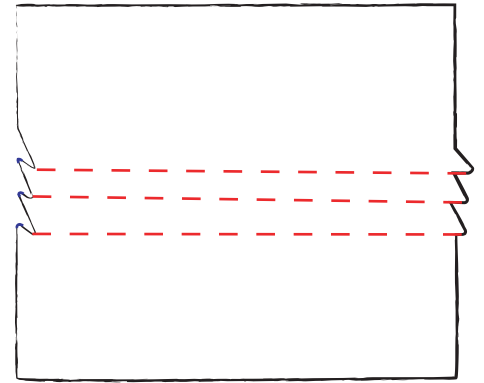
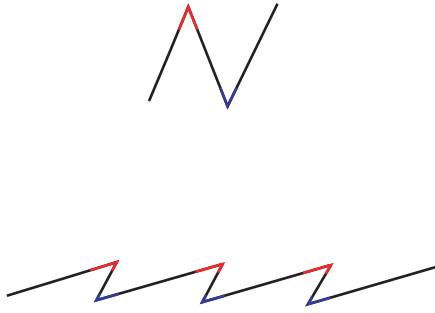
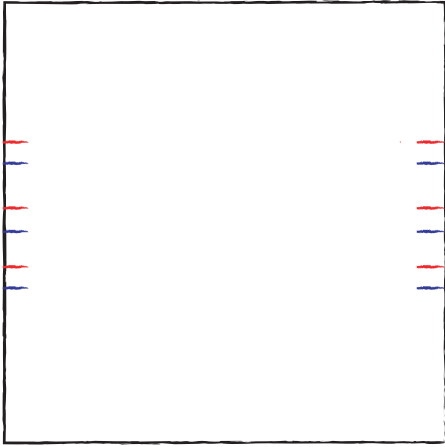

### 4. Coudre les plis

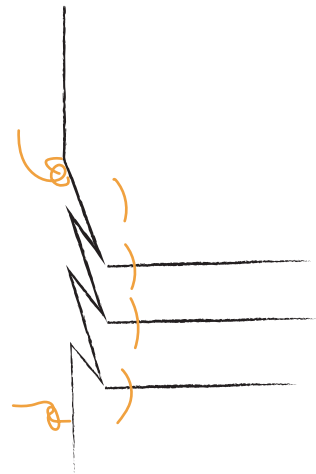
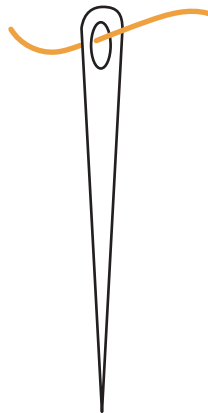
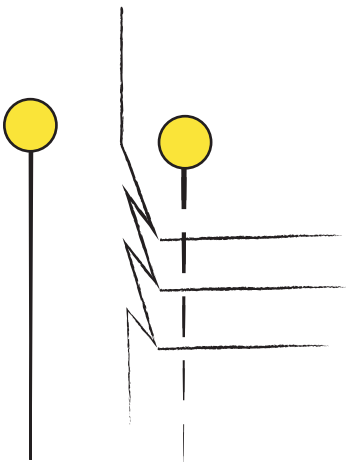

## 5. Assembler face à face

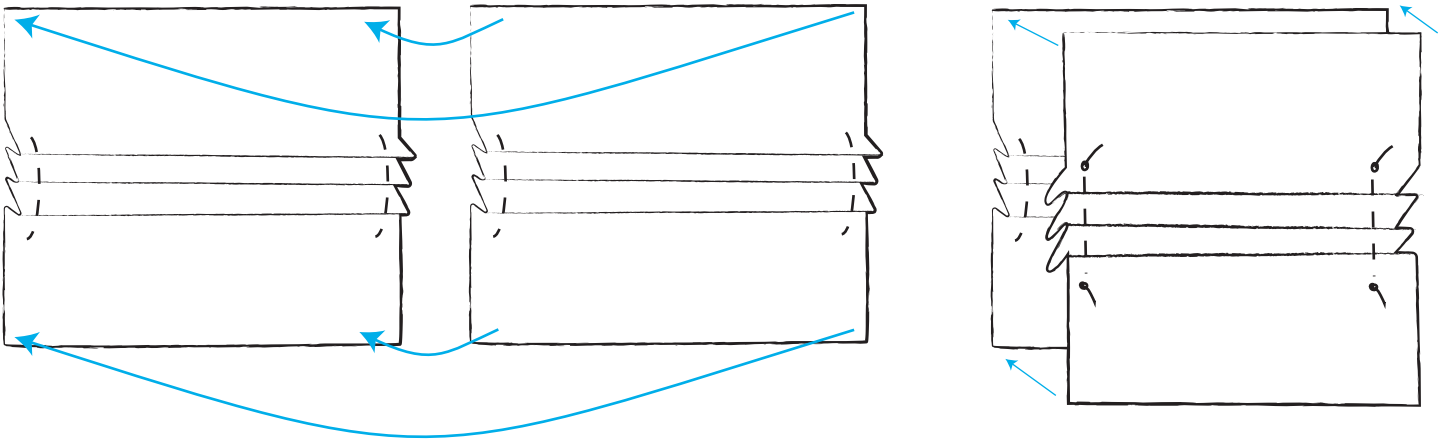

## 6. Coudre les côtés

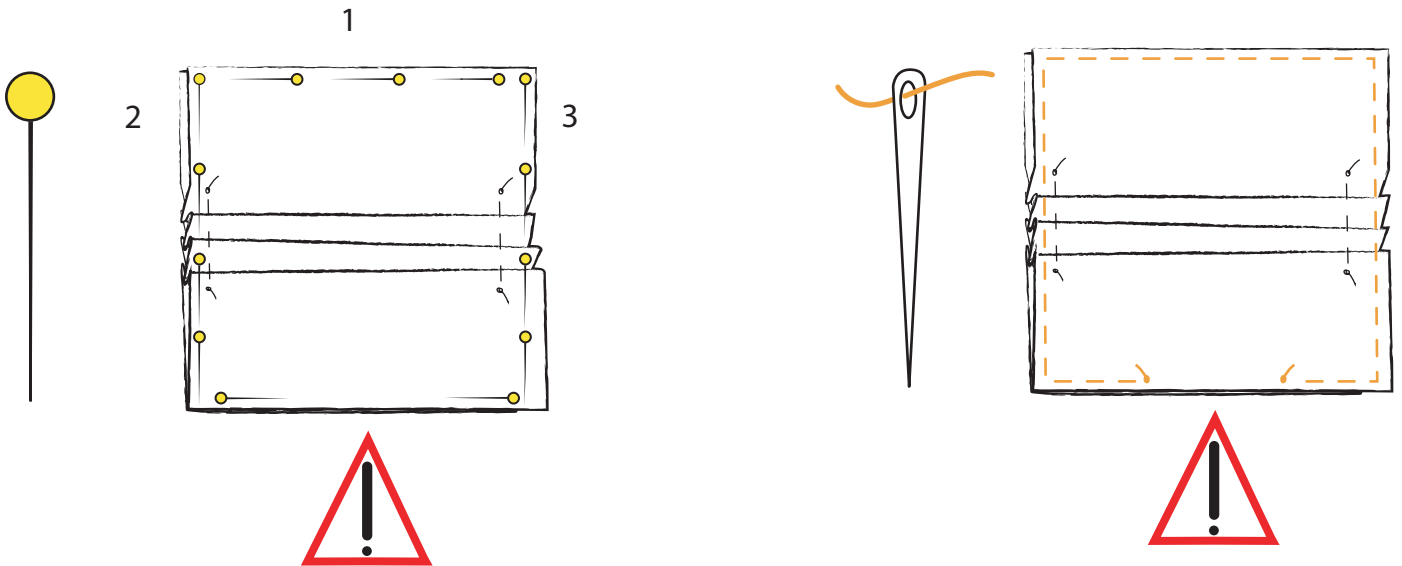

## 7. Retourner sur l'endroit

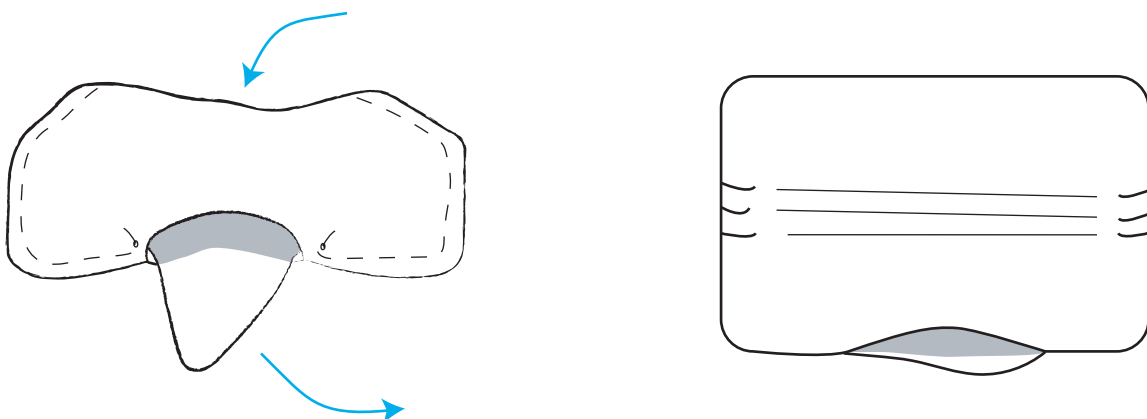

## 8. Coudre l'ouverture

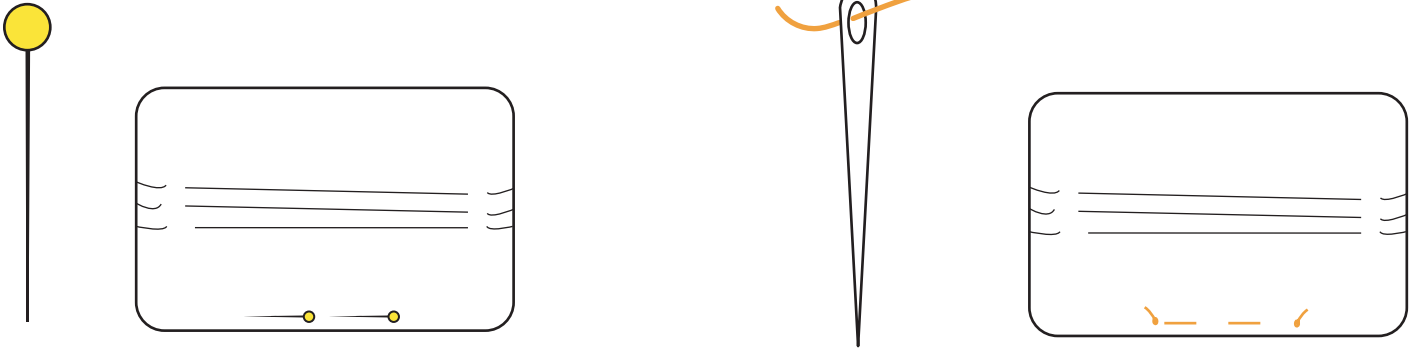

## 9. Coudre les lanières

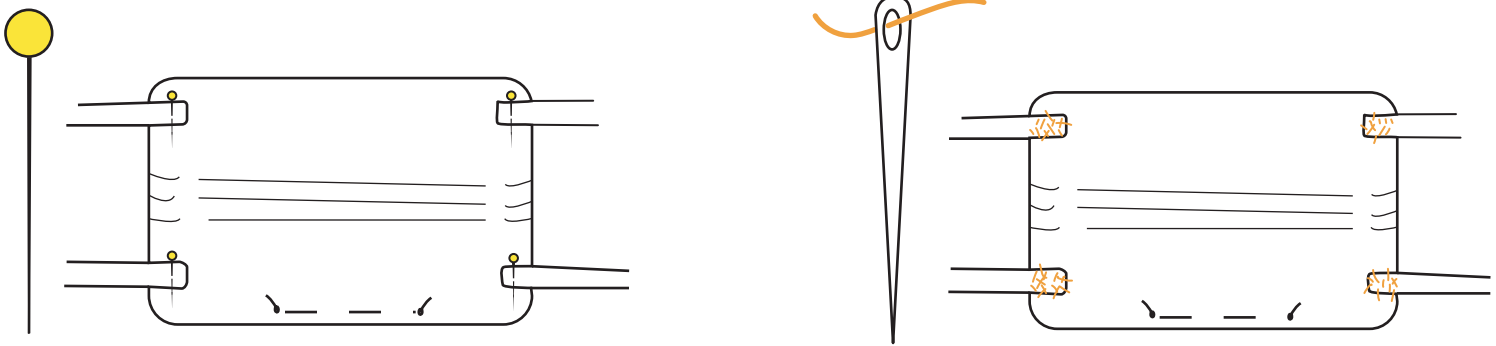

## 10. Mettre le masque

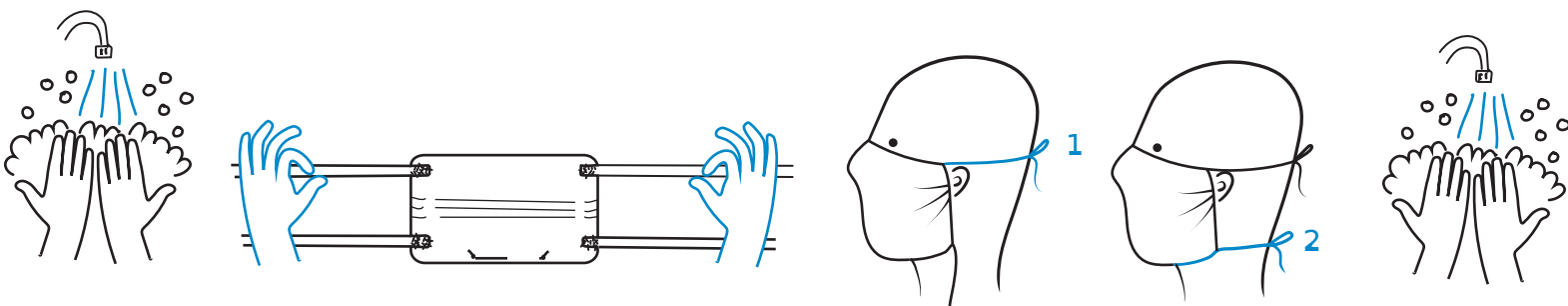

# Recommandations

## Laver le masque

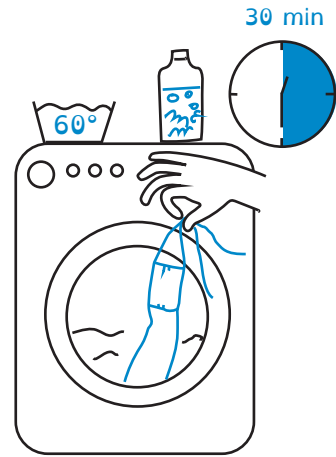
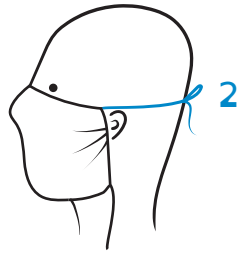
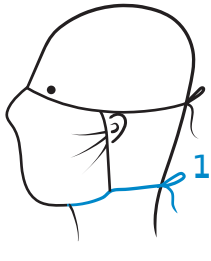
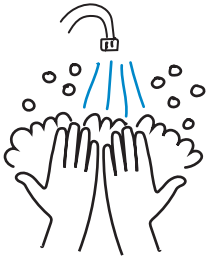

## Toucher le masque



## Boire avec le masque

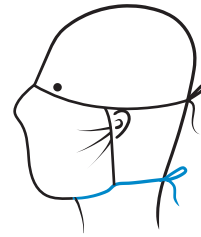
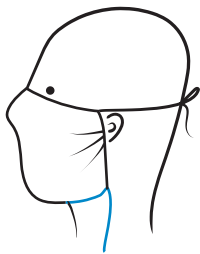

## Porter le masque

